



H.T. Lynac Sampler



2" COMPLETE ASSEMBLY

O.D.	Length	TPI	CONN	Part#	Weight (Lb)
2"	18"	4	AW	42C200-18AW-4	13
2"	18"	8	AW	42C200-18AW-8	13
2"	24"	4	AW	42C200-24AW-4	15
2"	24"	8	AW	42C200-24AW-8	15
2"	30"	4	AW	42C200-30AW-4	19
2"	30"	8	AW	42C200-30AW-8	19
2"	18"	4	AWJ	42C200-18AWJ-4	13
2"	18"	8	AWJ	42C200-18AWJ-8	13
2"	24"	4	AWJ	42C200-24AWJ-4	15
2"	24"	8	AWJ	42C200-24AWJ-8	15
2"	30"	4	AWJ	42C200-30AWJ-4	19
2"	30"	8	AWJ	42C200-30AWJ-8	19
2"	18"	4	NW	42C200-18NW-4	18
2"	18"	8	NW	42C200-18NW-8	18
2"	24"	4	NW	42C200-24NW-4	19
2"	24"	8	NW	42C200-24NW-8	19
2"	30"	4	NW	42C200-30NW-4	24
2"	30"	8	NW	42C200-30NW-8	24
2"	18"	4	NWJ	42C200-18NWJ-4	18
2"	18"	8	NWJ	42C200-18NWJ-8	18
2"	24"	4	NWJ	42C200-24NWJ-4	19
2"	24"	8	NWJ	42C200-24NWJ-8	19
2"	30"	4	NWJ	42C200-30NWJ-4	24
2"	30"	8	NWJ	42C200-30NWJ-8	24
2"	18"	4	N-3	42C200-18N3-4	16
2"	18"	8	N-3	42C200-18N3-8	16
2"	24"	4	N-3	42C200-24N3-4	19
2"	24"	8	N-3	42C200-24N3-8	19
2"	30"	4	N-3	42C200-30N3-4	21
2"	30"	8	N-3	42C200-30N3-8	21
2"	18"	4	MHJR	42C200-18MHJR-4	19
2"	18"	8	MHJR	42C200-18MHJR-8	19
2"	24"	4	MHJR	42C200-24MHJR-4	21
2"	24"	8	MHJR	42C200-24MHJR-8	21
2"	30"	4	MHJR	42C200-30MHJR-4	25
2"	30"	8	MHJR	42C200-30MHJR-8	25

** Please consult factory for special requirements.*



N&N Drilling Supply Mfr. • (800) 334-4927



H.T. Lynac Sampler



2-1/2" COMPLETE ASSEMBLY

O.D.	Length	TPI	CONN	Part#	Weight (Lb)
2-1/2"	18"	4	AW	42C212-18AW-4	23
2-1/2"	18"	8	AW	42C212-18AW-8	23
2-1/2"	24"	4	AW	42C212-24AW-4	25
2-1/2"	24"	8	AW	42C212-24AW-8	25
2-1/2"	30"	4	AW	42C212-30AW-4	29
2-1/2"	30"	8	AW	42C212-30AW-8	29
2-1/2"	18"	4	AWJ	42C212-18AWJ-4	23
2-1/2"	18"	8	AWJ	42C212-18AWJ-8	23
2-1/2"	24"	4	AWJ	42C212-24AWJ-4	25
2-1/2"	24"	8	AWJ	42C212-24AWJ-8	25
2-1/2"	30"	4	AWJ	42C212-30AWJ-4	29
2-1/2"	30"	8	AWJ	42C212-30AWJ-8	29
2-1/2"	18"	4	NW	42C212-18NW-4	28
2-1/2"	18"	8	NW	42C212-18NW-8	28
2-1/2"	24"	4	NW	42C212-24NW-4	29
2-1/2"	24"	8	NW	42C212-24NW-8	29
2-1/2"	30"	4	NW	42C212-30NW-4	34
2-1/2"	30"	8	NW	42C212-30NW-8	34
2-1/2"	18"	4	NWJ	42C212-18NWJ-4	28
2-1/2"	18"	8	NWJ	42C212-18NWJ-8	28
2-1/2"	24"	4	NWJ	42C212-24NWJ-4	29
2-1/2"	24"	8	NWJ	42C212-24NWJ-8	29
2-1/2"	30"	4	NWJ	42C212-30NWJ-4	34
2-1/2"	30"	8	NWJ	42C212-30NWJ-8	34
2-1/2"	18"	4	N-3	42C212-18N3-4	26
2-1/2"	18"	8	N-3	42C212-18N3-8	26
2-1/2"	24"	4	N-3	42C212-24N3-4	29
2-1/2"	24"	8	N-3	42C212-24N3-8	29
2-1/2"	30"	4	N-3	42C212-30N3-4	31
2-1/2"	30"	8	N-3	42C212-30N3-8	31
2-1/2"	18"	4	MHJR	42C212-18MHJR-4	29
2-1/2"	18"	8	MHJR	42C212-18MHJR-8	29
2-1/2"	24"	4	MHJR	42C212-24MHJR-4	31
2-1/2"	24"	8	MHJR	42C212-24MHJR-8	31
2-1/2"	30"	4	MHJR	42C212-30MHJR-4	35
2-1/2"	30"	8	MHJR	42C212-30MHJR-8	35

* Please consult factory for special requirements.



N&N Drilling Supply Mfr. • (800) 334-4927



H.T. Lynac Sampler



3" COMPLETE ASSEMBLY

O.D.	Length	TPI	CONN	Part#	Weight (Lb)
3"	18"	4	AW	42C300-18AW-4	31
3"	18"	8	AW	42C300-18AW-8	31
3"	24"	4	AW	42C300-24AW-4	37
3"	24"	8	AW	42C300-24AW-8	37
3"	30"	4	AW	42C300-30AW-4	43
3"	30"	8	AW	42C300-30AW-8	43
3"	18"	4	AWJ	42C300-18AWJ-4	31
3"	18"	8	AWJ	42C300-18AWJ-8	31
3"	24"	4	AWJ	42C300-24AWJ-4	37
3"	24"	8	AWJ	42C300-24AWJ-8	37
3"	30"	4	AWJ	42C300-30AWJ-4	43
3"	30"	8	AWJ	42C300-30AWJ-8	43
3"	18"	4	NW	42C300-18NW-4	29
3"	18"	8	NW	42C300-18NW-8	29
3"	24"	4	NW	42C300-24NW-4	35
3"	24"	8	NW	42C300-24NW-8	35
3"	30"	4	NW	42C300-30NW-4	41
3"	30"	8	NW	42C300-30NW-8	41
3"	18"	4	NWJ	42C300-18NWJ-4	30
3"	18"	8	NWJ	42C300-18NWJ-8	30
3"	24"	4	NWJ	42C300-24NWJ-4	36
3"	24"	8	NWJ	42C300-24NWJ-8	36
3"	30"	4	NWJ	42C300-30NWJ-4	42
3"	30"	8	NWJ	42C300-30NWJ-8	42
3"	18"	4	N-3	42C300-18N3-4	30
3"	18"	8	N-3	42C300-18N3-8	30
3"	24"	4	N-3	42C300-24N3-4	36
3"	24"	8	N-3	42C300-24N3-8	36
3"	30"	4	N-3	42C300-30N3-4	42
3"	30"	8	N-3	42C300-30N3-8	42
3"	18"	4	MHJR	42C300-18MHJR-4	30
3"	18"	8	MHJR	42C300-18MHJR-8	30
3"	24"	4	MHJR	42C300-24MHJR-4	36
3"	24"	8	MHJR	42C300-24MHJR-8	36
3"	30"	4	MHJR	42C300-30MHJR-4	42
3"	30"	8	MHJR	42C300-30MHJR-8	42

* Please consult factory for special requirements.



N&N Drilling Supply Mfr. • (800) 334-4927



H.T. Lynac Sampler



3-1/2" COMPLETE ASSEMBLY

O.D.	Length	TPI	CONN	Part#	Weight (Lb)
3-1/2"	18"	4	AW	42C312-18AW-4	43
3-1/2"	18"	8	AW	42C312-18AW-8	43
3-1/2"	24"	4	AW	42C312-24AW-4	49
3-1/2"	24"	8	AW	42C312-24AW-8	49
3-1/2"	30"	4	AW	42C312-30AW-4	55
3-1/2"	30"	8	AW	42C312-30AW-8	55
3-1/2"	18"	4	AWJ	42C312-18AWJ-4	43
3-1/2"	18"	8	AWJ	42C312-18AWJ-8	43
3-1/2"	24"	4	AWJ	42C312-24AWJ-4	49
3-1/2"	24"	8	AWJ	42C312-24AWJ-8	49
3-1/2"	30"	4	AWJ	42C312-30AWJ-4	55
3-1/2"	30"	8	AWJ	42C312-30AWJ-8	55
3-1/2"	18"	4	NW	42C312-18NW-4	41
3-1/2"	18"	8	NW	42C312-18NW-8	41
3-1/2"	24"	4	NW	42C312-24NW-4	47
3-1/2"	24"	8	NW	42C312-24NW-8	47
3-1/2"	30"	4	NW	42C312-30NW-4	53
3-1/2"	30"	8	NW	42C312-30NW-8	53
3-1/2"	18"	4	NWJ	42C312-18NWJ-4	42
3-1/2"	18"	8	NWJ	42C312-18NWJ-8	42
3-1/2"	24"	4	NWJ	42C312-24NWJ-4	48
3-1/2"	24"	8	NWJ	42C312-24NWJ-8	48
3-1/2"	30"	4	NWJ	42C312-30NWJ-4	54
3-1/2"	30"	8	NWJ	42C312-30NWJ-8	54
3-1/2"	18"	4	N-3	42C312-18N3-4	42
3-1/2"	18"	8	N-3	42C312-18N3-8	42
3-1/2"	24"	4	N-3	42C312-24N3-4	48
3-1/2"	24"	8	N-3	42C312-24N3-8	48
3-1/2"	30"	4	N-3	42C312-30N3-4	52
3-1/2"	30"	8	N-3	42C312-30N3-8	52
3-1/2"	18"	4	MHJR	42C312-18MHJR-4	42
3-1/2"	18"	8	MHJR	42C312-18MHJR-8	42
3-1/2"	24"	4	MHJR	42C312-24MHJR-4	48
3-1/2"	24"	8	MHJR	42C312-24MHJR-8	48
3-1/2"	30"	4	MHJR	42C312-30MHJR-4	54
3-1/2"	30"	8	MHJR	42C312-30MHJR-8	54

* Please consult factory for special requirements.



N&N Drilling Supply Mfr. • (800) 334-4927



H.T. Lynac Sampler



4" COMPLETE ASSEMBLY

O.D.	Length	TPI	CONN	Part#	Weight (Lb)
4"	18"	4	AW	42C400-18AW-4	48
4"	18"	8	AW	42C400-18AW-8	48
4"	24"	4	AW	42C400-24AW-4	54
4"	24"	8	AW	42C400-24AW-8	54
4"	30"	4	AW	42C400-30AW-4	60
4"	30"	8	AW	42C400-30AW-8	60
4"	18"	4	AWJ	42C400-18AWJ-4	48
4"	18"	8	AWJ	42C400-18AWJ-8	48
4"	24"	4	AWJ	42C400-24AWJ-4	54
4"	24"	8	AWJ	42C400-24AWJ-8	54
4"	30"	4	AWJ	42C400-30AWJ-4	60
4"	30"	8	AWJ	42C400-30AWJ-8	60
4"	18"	4	NW	42C400-18NW-4	46
4"	18"	8	NW	42C400-18NW-8	46
4"	24"	4	NW	42C400-24NW-4	52
4"	24"	8	NW	42C400-24NW-8	52
4"	30"	4	NW	42C400-30NW-4	58
4"	30"	8	NW	42C400-30NW-8	58
4"	18"	4	NWJ	42C400-18NWJ-4	47
4"	18"	8	NWJ	42C400-18NWJ-8	47
4"	24"	4	NWJ	42C400-24NWJ-4	53
4"	24"	8	NWJ	42C400-24NWJ-8	53
4"	30"	4	NWJ	42C400-30NWJ-4	59
4"	30"	8	NWJ	42C400-30NWJ-8	59
4"	18"	4	N-3	42C400-18N3-4	47
4"	18"	8	N-3	42C400-18N3-8	47
4"	24"	4	N-3	42C400-24N3-4	53
4"	24"	8	N-3	42C500-24N3-8	53
4"	30"	4	N-3	42C400-30N3-4	59
4"	30"	8	N-3	42C400-30N3-8	59
4"	18"	4	MHJR	42C400-18MHJR-4	47
4"	18"	8	MHJR	42C400-18MHJR-8	47
4"	24"	4	MHJR	42C400-24MHJR-4	53
4"	24"	8	MHJR	42C400-24MHJR-8	53
4"	30"	4	MHJR	42C400-30MHJR-4	59
4"	30"	8	MHJR	42C400-30MHJR-8	59

** Please consult factory for special requirements.*



N&N Drilling Supply Mfr. • (800) 334-4927



H.T. Lynac Barrel

O.D.	Length	TPI	Part#	Weight (Lb)
2"	18"	4	42B200-18-4	8
2"	18"	8	42B200-18-8	8
2"	24"	4	42B200-24-4	10
2"	24"	8	42B200-24-8	10
2"	30"	4	42B200-30-4	13
2"	30"	8	42B200-30-8	13
2-1/2"	18"	4	42B212-18-4	12
2-1/2"	18"	8	42B212-18-8	12
2-1/2"	24"	4	42B212-24-4	16
2-1/2"	24"	8	42B212-24-8	16
2-1/2"	30"	4	42B212-30-4	19
2-1/2"	30"	8	42B212-30-8	19
3"	18"	4	42B300-18-4	16
3"	18"	8	42B300-18-8	16
3"	24"	4	42B300-24-4	20
3"	24"	8	42B300-24-8	20
3"	30"	4	42B300-30-4	24
3"	30"	8	42B300-30-8	24
3-1/2"	18"	4	42B312-18-4	20
3-1/2"	18"	8	42B312-18-8	20
3-1/2"	24"	4	42B312-24-4	25
3-1/2"	24"	8	42B312-24-8	25
3-1/2"	30"	4	42B312-30-4	30
3-1/2"	30"	8	42B312-30-8	30
4"	18"	4	42B400-18-4	24
4"	18"	8	42B400-18-8	24
4"	24"	4	42B400-24-4	30
4"	24"	8	42B400-24-8	30
4"	30"	4	42B400-30-4	36
4"	30"	8	42B400-30-8	36

* Please consult factory for special requirements.



N&N Drilling Supply Mfr. • (800) 334-4927



H.T. Lynac
"H.D." Sampler



2" COMPLETE ASSEMBLY

O.D.	Length	TPI	CONN	Part#	Weight (Lb)
2"	18"	4	AW	42C200-18AW-4HD	13
2"	18"	8	AW	42C200-18AW-8HD	13
2"	24"	4	AW	42C200-24AW-4HD	15
2"	24"	8	AW	42C200-24AW-8HD	15
2"	30"	4	AW	42C200-30AW-4HD	19
2"	30"	8	AW	42C200-30AW-8HD	19
2"	18"	4	AWJ	42C200-18AWJ-4HD	13
2"	18"	8	AWJ	42C200-18AWJ-8HD	13
2"	24"	4	AWJ	42C200-24AWJ-4HD	15
2"	24"	8	AWJ	42C200-24AWJ-8HD	15
2"	30"	4	AWJ	42C200-30AWJ-4HD	19
2"	30"	8	AWJ	42C200-30AWJ-8HD	19
2"	18"	4	NW	42C200-18NW-4HD	18
2"	18"	8	NW	42C200-18NW-8HD	18
2"	24"	4	NW	42C200-24NW-4HD	19
2"	24"	8	NW	42C200-24NW-8HD	19
2"	30"	4	NW	42C200-30NW-4HD	24
2"	30"	8	NW	42C200-30NW-8HD	24
2"	18"	4	NWJ	42C200-18NWJ-4HD	18
2"	18"	8	NWJ	42C200-18NWJ-8HD	18
2"	24"	4	NWJ	42C200-24NWJ-4HD	19
2"	24"	8	NWJ	42C200-24NWJ-8HD	19
2"	30"	4	NWJ	42C200-30NWJ-4HD	24
2"	30"	8	NWJ	42C200-30NWJ-8HD	24
2"	18"	4	N-3	42C200-18N3-4HD	16
2"	18"	8	N-3	42C200-18N3-8HD	16
2"	24"	4	N-3	42C200-24N3-4HD	19
2"	24"	8	N-3	42C200-24N3-8HD	19
2"	30"	4	N-3	42C200-30N3-4HD	21
2"	30"	8	N-3	42C200-30N3-8HD	21
2"	18"	4	MHJR	42C200-18MHJR-4HD	19
2"	18"	8	MHJR	42C200-18MHJR-8HD	19
2"	24"	4	MHJR	42C200-24MHJR-4HD	21
2"	24"	8	MHJR	42C200-24MHJR-8HD	21
2"	30"	4	MHJR	42C200-30MHJR-4HD	25
2"	30"	8	MHJR	42C200-30MHJR-8HD	25

** Please consult factory for special requirements.*



N&N Drilling Supply Mfr. • (800) 334-4927



H.T. Lynac
"H.D." Sampler



2-1/2" COMPLETE ASSEMBLY

O.D.	Length	TPI	CONN	Part#	Weight (Lb)
2-1/2"	18"	4	AW	42C212-18AW-4HD	23
2-1/2"	18"	8	AW	42C212-18AW-8HD	23
2-1/2"	24"	4	AW	42C212-24AW-4HD	25
2-1/2"	24"	8	AW	42C212-24AW-8HD	25
2-1/2"	30"	4	AW	42C212-30AW-4HD	29
2-1/2"	30"	8	AW	42C212-30AW-8HD	29
2-1/2"	18"	4	AWJ	42C212-18AWJ-4HD	23
2-1/2"	18"	8	AWJ	42C212-18AWJ-8HD	23
2-1/2"	24"	4	AWJ	42C212-24AWJ-4HD	25
2-1/2"	24"	8	AWJ	42C212-24AWJ-8HD	25
2-1/2"	30"	4	AWJ	42C212-30AWJ-4HD	29
2-1/2"	30"	8	AWJ	42C212-30AWJ-8HD	29
2-1/2"	18"	4	NW	42C212-18NW-4HD	28
2-1/2"	18"	8	NW	42C212-18NW-8HD	28
2-1/2"	24"	4	NW	42C212-24NW-4HD	29
2-1/2"	24"	8	NW	42C212-24NW-8HD	29
2-1/2"	30"	4	NW	42C212-30NW-4HD	34
2-1/2"	30"	8	NW	42C212-30NW-8HD	34
2-1/2"	18"	4	NWJ	42C212-18NWJ-4HD	28
2-1/2"	18"	8	NWJ	42C212-18NWJ-8HD	28
2-1/2"	24"	4	NWJ	42C212-24NWJ-4HD	29
2-1/2"	24"	8	NWJ	42C212-24NWJ-8HD	29
2-1/2"	30"	4	NWJ	42C212-30NWJ-4HD	34
2-1/2"	30"	8	NWJ	42C212-30NWJ-8HD	34
2-1/2"	18"	4	N-3	42C212-18N3-4HD	26
2-1/2"	18"	8	N-3	42C212-18N3-8HD	26
2-1/2"	24"	4	N-3	42C212-24N3-4HD	29
2-1/2"	24"	8	N-3	42C212-24N3-8HD	29
2-1/2"	30"	4	N-3	42C212-30N3-4HD	31
2-1/2"	30"	8	N-3	42C212-30N3-8HD	31
2-1/2"	18"	4	MHJR	42C212-18MHJR-4HD	29
2-1/2"	18"	8	MHJR	42C212-18MHJR-8HD	29
2-1/2"	24"	4	MHJR	42C212-24MHJR-4HD	31
2-1/2"	24"	8	MHJR	42C212-24MHJR-8HD	31
2-1/2"	30"	4	MHJR	42C212-30MHJR-4HD	35
2-1/2"	30"	8	MHJR	42C212-30MHJR-8HD	35

* Please consult factory for special requirements.



N&N Drilling Supply Mfr. • (800) 334-4927



H.T. Lynac
"H.D." Sampler



3" COMPLETE ASSEMBLY

O.D.	Length	TPI	CONN	Part#	Weight (Lb)
3"	18"	4	AW	42C300-18AW-4HD	31
3"	18"	8	AW	42C300-18AW-8HD	31
3"	24"	4	AW	42C300-24AW-4HD	37
3"	24"	8	AW	42C300-24AW-8HD	37
3"	30"	4	AW	42C300-30AW-4HD	43
3"	30"	8	AW	42C300-30AW-8HD	43
3"	18"	4	AWJ	42C300-18AWJ-4HD	31
3"	18"	8	AWJ	42C300-18AWJ-8HD	31
3"	24"	4	AWJ	42C300-24AWJ-4HD	37
3"	24"	8	AWJ	42C300-24AWJ-8HD	37
3"	30"	4	AWJ	42C300-30AWJ-4HD	43
3"	30"	8	AWJ	42C300-30AWJ-8HD	43
3"	18"	4	NW	42C300-18NW-4HD	29
3"	18"	8	NW	42C300-18NW-8HD	29
3"	24"	4	NW	42C300-24NW-4HD	35
3"	24"	8	NW	42C300-24NW-8HD	35
3"	30"	4	NW	42C300-30NW-4HD	41
3"	30"	8	NW	42C300-30NW-8HD	41
3"	18"	4	NWJ	42C300-18NWJ-4HD	30
3"	18"	8	NWJ	42C300-18NWJ-8HD	30
3"	24"	4	NWJ	42C300-24NWJ-4HD	36
3"	24"	8	NWJ	42C300-24NWJ-8HD	36
3"	30"	4	NWJ	42C300-30NWJ-4HD	42
3"	30"	8	NWJ	42C300-30NWJ-8HD	42
3"	18"	4	N-3	42C300-18N3-4HD	30
3"	18"	8	N-3	42C300-18N3-8HD	30
3"	24"	4	N-3	42C300-24N3-4HD	36
3"	24"	8	N-3	42C300-24N3-8HD	36
3"	30"	4	N-3	42C300-30N3-4HD	42
3"	30"	8	N-3	42C300-30N3-8HD	42
3"	18"	4	MHJR	42C300-18MHJR-4HD	30
3"	18"	8	MHJR	42C300-18MHJR-8HD	30
3"	24"	4	MHJR	42C300-24MHJR-4HD	36
3"	24"	8	MHJR	42C300-24MHJR-8HD	36
3"	30"	4	MHJR	42C300-30MHJR-4HD	42
3"	30"	8	MHJR	42C300-30MHJR-8HD	42

** Please consult factory for special requirements.*



N&N Drilling Supply Mfr. • (800) 334-4927



H.T. Lynac
"H.D." Sampler



3-1/2" COMPLETE ASSEMBLY

O.D.	Length	TPI	CONN	Part#	Weight (Lb)
3-1/2"	18"	4	AW	42C312-18AW-4HD	43
3-1/2"	18"	8	AW	42C312-18AW-8HD	43
3-1/2"	24"	4	AW	42C312-24AW-4HD	49
3-1/2"	24"	8	AW	42C312-24AW-8HD	49
3-1/2"	30"	4	AW	42C312-30AW-4HD	55
3-1/2"	30"	8	AW	42C312-30AW-8HD	55
3-1/2"	18"	4	AWJ	42C312-18AWJ-4HD	43
3-1/2"	18"	8	AWJ	42C312-18AWJ-8HD	43
3-1/2"	24"	4	AWJ	42C312-24AWJ-4HD	49
3-1/2"	24"	8	AWJ	42C312-24AWJ-8HD	49
3-1/2"	30"	4	AWJ	42C312-30AWJ-4HD	55
3-1/2"	30"	8	AWJ	42C312-30AWJ-8HD	55
3-1/2"	18"	4	NW	42C312-18NW-4HD	41
3-1/2"	18"	8	NW	42C312-18NW-8HD	41
3-1/2"	24"	4	NW	42C312-24NW-4HD	47
3-1/2"	24"	8	NW	42C312-24NW-8HD	47
3-1/2"	30"	4	NW	42C312-30NW-4HD	53
3-1/2"	30"	8	NW	42C312-30NW-8HD	53
3-1/2"	18"	4	NWJ	42C312-18NWJ-4HD	42
3-1/2"	18"	8	NWJ	42C312-18NWJ-8HD	42
3-1/2"	24"	4	NWJ	42C312-24NWJ-4HD	48
3-1/2"	24"	8	NWJ	42C312-24NWJ-8HD	48
3-1/2"	30"	4	NWJ	42C312-30NWJ-4HD	54
3-1/2"	30"	8	NWJ	42C312-30NWJ-8HD	54
3-1/2"	18"	4	N-3	42C312-18N3-4HD	42
3-1/2"	18"	8	N-3	42C312-18N3-8HD	42
3-1/2"	24"	4	N-3	42C312-24N3-4HD	48
3-1/2"	24"	8	N-3	42C312-24N3-8HD	48
3-1/2"	30"	4	N-3	42C312-30N3-4HD	52
3-1/2"	30"	8	N-3	42C312-30N3-8HD	52
3-1/2"	18"	4	MHJR	42C312-18MHJR-4HD	42
3-1/2"	18"	8	MHJR	42C312-18MHJR-8HD	42
3-1/2"	24"	4	MHJR	42C312-24MHJR-4HD	48
3-1/2"	24"	8	MHJR	42C312-24MHJR-8HD	48
3-1/2"	30"	4	MHJR	42C312-30MHJR-4HD	54
3-1/2"	30"	8	MHJR	42C312-30MHJR-8HD	54

* Please consult factory for special requirements.



N&N Drilling Supply Mfr. • (800) 334-4927



H.T. Lynac
"H.D." Sampler



4" COMPLETE ASSEMBLY

O.D.	Length	TPI	CONN	Part#	Weight (Lb)
4"	18"	4	AW	42C400-18AW-4HD	48
4"	18"	8	AW	42C400-18AW-8HD	48
4"	24"	4	AW	42C400-24AW-4HD	54
4"	24"	8	AW	42C400-24AW-8HD	54
4"	30"	4	AW	42C400-30AW-4HD	60
4"	30"	8	AW	42C400-30AW-8HD	60
4"	18"	4	AWJ	42C400-18AWJ-4HD	48
4"	18"	8	AWJ	42C400-18AWJ-8HD	48
4"	24"	4	AWJ	42C400-24AWJ-4HD	54
4"	24"	8	AWJ	42C400-24AWJ-8HD	54
4"	30"	4	AWJ	42C400-30AWJ-4HD	60
4"	30"	8	AWJ	42C400-30AWJ-8HD	60
4"	18"	4	NW	42C400-18NW-4HD	46
4"	18"	8	NW	42C400-18NW-8HD	46
4"	24"	4	NW	42C400-24NW-4HD	52
4"	24"	8	NW	42C400-24NW-8HD	52
4"	30"	4	NW	42C400-30NW-4HD	58
4"	30"	8	NW	42C400-30NW-8HD	58
4"	18"	4	NWJ	42C400-18NWJ-4HD	47
4"	18"	8	NWJ	42C400-18NWJ-8HD	47
4"	24"	4	NWJ	42C400-24NWJ-4HD	53
4"	24"	8	NWJ	42C400-24NWJ-8HD	53
4"	30"	4	NWJ	42C400-30NWJ-4HD	59
4"	30"	8	NWJ	42C400-30NWJ-8HD	59
4"	18"	4	N-3	42C400-18N3-4HD	47
4"	18"	8	N-3	42C400-18N3-8HD	47
4"	24"	4	N-3	42C400-24N3-4HD	53
4"	24"	8	N-3	42C500-24N3-8HD	53
4"	30"	4	N-3	42C400-30N3-4HD	59
4"	30"	8	N-3	42C400-30N3-8HD	59
4"	18"	4	MHJR	42C400-18MHJR-4HD	47
4"	18"	8	MHJR	42C400-18MHJR-8HD	47
4"	24"	4	MHJR	42C400-24MHJR-4HD	53
4"	24"	8	MHJR	42C400-24MHJR-8HD	53
4"	30"	4	MHJR	42C400-30MHJR-4HD	59
4"	30"	8	MHJR	42C400-30MHJR-8HD	59

** Please consult factory for special requirements.*



N&N Drilling Supply Mfr. • (800) 334-4927



H.T. Lynac "H.D." Barrel

O.D.	Length	TPI	Part#	Weight (Lb)
2"	18"	4	42B200-18-4HD	9
2"	18"	8	42B200-18-8HD	9
2"	24"	4	42B200-24-4HD	12
2"	24"	8	42B200-24-8HD	12
2"	30"	4	42B200-30-4HD	14
2"	30"	8	42B200-30-8HD	14
2-1/2"	18"	4	42B212-18-4HD	12
2-1/2"	18"	8	42B212-18-8HD	12
2-1/2"	24"	4	42B212-24-4HD	16
2-1/2"	24"	8	42B212-24-8HD	16
2-1/2"	30"	4	42B212-30-4HD	19
2-1/2"	30"	8	42B212-30-8HD	19
3"	18"	4	42B300-18-4HD	16
3"	18"	8	42B300-18-8HD	16
3"	24"	4	42B300-24-4HD	20
3"	24"	8	42B300-24-8HD	20
3"	30"	4	42B300-30-4HD	25
3"	30"	8	42B300-30-8HD	25
3-1/2"	18"	4	42B312-18-4HD	21
3-1/2"	18"	8	42B312-18-8HD	21
3-1/2"	24"	4	42B312-24-4HD	27
3-1/2"	24"	8	42B312-24-8HD	27
3-1/2"	30"	4	42B312-30-4HD	32
3-1/2"	30"	8	42B312-30-8HD	32
4"	18"	4	42B400-18-4HD	25
4"	18"	8	42B400-18-8HD	25
4"	24"	4	42B400-24-4HD	32
4"	24"	8	42B400-24-8HD	32
4"	30"	4	42B400-30-4HD	38
4"	30"	8	42B400-30-8HD	38

* Please consult factory for special requirements.



N&N Drilling Supply Mfr. • (800) 334-4927

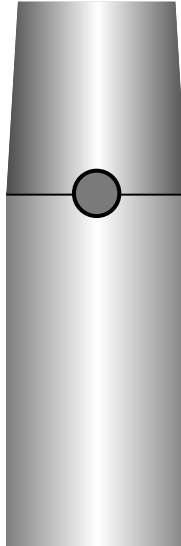

Lync Head Assembly

O.D.	Connection	Part#	Weight (Lb)
2"	AW	42H200-AW	3
2"	AWJ	42H200-AWJ	3
2"	NW	42H200-NW	7
2"	NWJ	42H200-NWJ	7
2"	N-3	42H200-N3	7
2"	MHJR	42H200-MHJR	9
2-1/2"	AW	42H212-AW	7
2-1/2"	AWJ	42H212-AWJ	7
2-1/2"	NW	42H212-NW	8
2-1/2"	NWJ	42H212-NWJ	8
2-1/2"	N-3	42H212-N3	8
2-1/2"	MHJR	42H212-MHJR	10
3"	AW	42H300-AW	12
3"	AWJ	42H300-AWJ	12
3"	NW	42H300-NW	12
3"	NWJ	42H300-NWJ	12
3"	N-3	42H300-N3	12
3"	MHJR	42H300-MHJR	12
3-1/2"	AW	42H312-AW	18
3-1/2"	AWJ	42H312-AWJ	18
3-1/2"	NW	42H312-NW	18
3-1/2"	NWJ	42H312-NWJ	18
3-1/2"	N-3	42H312-N3	18
3-1/2"	MHJR	42H312-MHJR	18
4"	AW	42H400-AW	22
4"	AWJ	42H400-AWJ	22
4"	NW	42H400-NW	22
4"	NWJ	42H400-NWJ	22
4"	N-3	42H400-N3	22
4"	MHJR	42H400-MHJR	22

** Please consult factory for special requirements.*

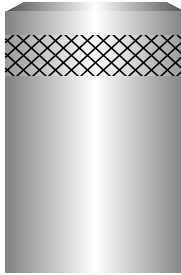

H.T. SHOE / BLUNT

H.T. SAMPLER SHOE / BLUNT

O.D.	TPI	Part#	Weight (Lb)
1-1/2"	8	40B112-8	0.7
1-3/4"	8	40B134-8	0.8
2"	4	40B200-4	1.0
2"	8	40B200-8	1.0
2-1/2"	4	40B212-4	1.2
2-1/2"	8	40B212-8	1.2
3"	4	40B300-4	1.5
3"	8	40B300-8	1.5
3-1/2"	4	40B312-4	1.9
3-1/2"	8	40B312-8	1.9
4"	4	40B400-4	2.7
4"	8	40B400-8	2.7
4-1/2"	4	40B412-4	3.2
4-1/2"	8	40B412-8	3.2

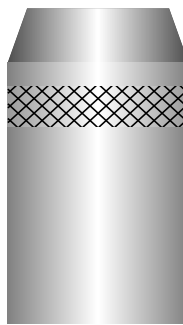

H.T. SHOE / SHARP

H.T. SAMPLER SHOE / SHARP

O.D.	TPI	Part#	Weight (Lb)
1-1/2"	8	40S112-8	0.7
1-3/4"	8	40S134-8	0.8
2"	4	40S200-4	1.0
2"	8	40S200-8	1.0
2-1/2"	4	40S212-4	1.2
2-1/2"	8	40S212-8	1.2
3"	4	40S300-4	1.5
3"	8	40S300-8	1.5
3-1/2"	4	40S312-4	1.9
3-1/2"	8	40S312-8	1.9
4"	4	40S400-4	2.7
4"	8	40S400-8	2.7
4-1/2"	4	40S412-4	3.2
4-1/2"	8	40S412-8	3.2

*** NOTE: Shoes fit Lynac, Lynac "H.D.", N&N Lynac, Standard and California Modified Samplers.**

*** Please consult factory for special requirements.**



N&N LYNAC SAMPLERS (COMPLETE)

N&N Drilling Supply Mfr. • (800) 334-4927



N&N Lynac Sampler

O.D.	I.D.	Length	TPI	CONN	Part#	Weight (Lb)
2"	1-3/8"	18"	4	AW	43C200-18AW-4	14
2"	1-3/8"	18"	8	AW	43C200-18AW-8	14
2"	1-3/8"	24"	4	AW	43C200-24AW-4	16
2"	1-3/8"	24"	8	AW	43C200-24AW-8	16
2"	1-3/8"	30"	4	AW	43C200-30AW-4	20
2"	1-3/8"	30"	8	AW	43C200-30AW-8	20
2"	1-3/8"	18"	4	AWJ	43C200-18AWJ-4	14
2"	1-3/8"	18"	8	AWJ	43C200-18AWJ-8	14
2"	1-3/8"	24"	4	AWJ	43C200-24AWJ-4	16
2"	1-3/8"	24"	8	AWJ	43C200-24AWJ-8	16
2"	1-3/8"	30"	4	AWJ	43C200-30AWJ-4	20
2"	1-3/8"	30"	8	AWJ	43C200-30AWJ-8	20
2"	1-3/8"	18"	4	NW	43C200-18NW-4	19
2"	1-3/8"	18"	8	NW	43C200-18NW-8	19
2"	1-3/8"	24"	4	NW	43C200-24NW-4	20
2"	1-3/8"	24"	8	NW	43C200-24NW-8	20
2"	1-3/8"	30"	4	NW	43C200-30NW-4	26
2"	1-3/8"	30"	8	NW	43C200-30NW-8	26
2"	1-3/8"	18"	4	NWJ	43C200-18NWJ-4	19
2"	1-3/8"	18"	8	NWJ	43C200-18NWJ-8	19
2"	1-3/8"	24"	4	NWJ	43C200-24NWJ-4	20
2"	1-3/8"	24"	8	NWJ	43C200-24NWJ-8	20
2"	1-3/8"	30"	4	NWJ	43C200-30NWJ-4	26
2"	1-3/8"	30"	8	NWJ	43C200-30NWJ-8	26
2"	1-3/8"	18"	4	N-3	43C200-18N3-4	17
2"	1-3/8"	18"	8	N-3	43C200-18N3-8	17
2"	1-3/8"	24"	4	N-3	43C200-24N3-4	20
2"	1-3/8"	24"	8	N-3	43C200-24N3-8	20
2"	1-3/8"	30"	4	N-3	43C200-30N3-4	23
2"	1-3/8"	30"	8	N-3	43C200-30N3-8	23
2"	1-3/8"	18"	4	MHJR	43C200-18MHJR-4	20
2"	1-3/8"	18"	8	MHJR	43C200-18MHJR-8	20
2"	1-3/8"	24"	4	MHJR	43C200-24MHJR-4	22
2"	1-3/8"	24"	8	MHJR	43C200-24MHJR-8	22
2"	1-3/8"	30"	4	MHJR	43C200-30MHJR-4	27
2"	1-3/8"	30"	8	MHJR	43C200-30MHJR-8	27

* NOTE: N&N Lynac will not accept liner.

* Please consult factory for special requirements.



N&N LYNAC BARREL

N&N LYNAC BARREL

O.D.	I.D.	Length	TPI	Part#	Weight (Lb)
2"	1-3/8"	18"	4	42B200-18-4NN	11
2"	1-3/8"	18"	8	42B200-18-8NN	11
2"	1-3/8"	24"	4	42B200-24-4NN	14
2"	1-3/8"	24"	8	42B200-24-8NN	14
2"	1-3/8"	30"	4	42B200-30-4NN	17
2"	1-3/8"	30"	8	42B200-30-8NN	17

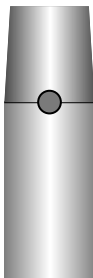

Lynac Head Assembly

LYNAC HEAD ASSEMBLY

O.D.	Connection	Part#	Weight (Lb)
2"	AW	42H200-AW	3
2"	AWJ	42H200-AWJ	3
2"	NW	42H200-NW	7
2"	NWJ	42H200-NWJ	7
2"	N-3	42H200-N3	7
2"	MHJR	42H200-MHJR	9



H.T. Sampler Shoe

H.T. SAMPLER SHOE

O.D.	TPI	Part#	Weight (Lb)
2"	4	40B200-4	1
2"	8	40B200-8	1
2"	4	40S200-4	1
2"	8	40S200-8	1

** Please consult factory for special requirements.*



STANDARD SAMPLERS (COMPLETE)

N&N Drilling Supply Mfr. • (800) 334-4927



Standard Sampler Assembly



1-1/2" COMPLETE ASSEMBLY

O.D.	Length	TPI	CONN	Part#	Weight (Lb)
1-1/2"	18"	8	AW	41C112-18AW-8	8
1-1/2"	24"	8	AW	41C112-24AW-8	9
1-1/2"	30"	8	AW	41C112-30AW-8	11
1-1/2"	18"	8	AWJ	41C112-18AWJ-8	8
1-1/2"	24"	8	AWJ	41C112-24AWJ-8	9
1-1/2"	30"	8	AWJ	41C112-30AWJ-8	11

1-3/4" COMPLETE ASSEMBLY

O.D.	Length	TPI	CONN	Part#	Weight (Lb)
1-3/4"	18"	8	AW	41C134-18AW-8	9
1-3/4"	24"	8	AW	41C134-24AW-8	11
1-3/4"	30"	8	AW	41C134-30AW-8	13
1-3/4"	18"	8	AWJ	41C134-18AWJ-8	9
1-3/4"	24"	8	AWJ	41C134-24AWJ-8	11
1-3/4"	30"	8	AWJ	41C134-30AWJ-8	13

** Please consult factory for special requirements.*



STANDARD SAMPLERS (COMPLETE)

N&N Drilling Supply Mfr. • (800) 334-4927



Standard Sampler
Assembly



2" COMPLETE ASSEMBLY

O.D.	Length	TPI	CONN	Part#	Weight (Lb)
2"	18"	4	AW	41C200-18AW-4	10
2"	18"	8	AW	41C200-18AW-8	10
2"	24"	4	AW	41C200-24AW-4	12
2"	24"	8	AW	41C200-24AW-8	12
2"	30"	4	AW	41C200-30AW-4	15
2"	30"	8	AW	41C200-30AW-8	15
2"	18"	4	AWJ	41C200-18AWJ-4	10
2"	18"	8	AWJ	41C200-18AWJ-8	10
2"	24"	4	AWJ	41C200-24AWJ-4	12
2"	24"	8	AWJ	41C200-24AWJ-8	12
2"	30"	4	AWJ	41C200-30AWJ-4	15
2"	30"	8	AWJ	41C200-30AWJ-8	15
2"	18"	4	NW	41C200-18NW-4	15
2"	18"	8	NW	41C200-18NW-8	15
2"	24"	4	NW	41C200-24NW-4	17
2"	24"	8	NW	41C200-24NW-8	17
2"	30"	4	NW	41C200-30NW-4	19
2"	30"	8	NW	41C200-30NW-8	19
2"	18"	4	NWJ	41C200-18NWJ-4	15
2"	18"	8	NWJ	41C200-18NWJ-8	15
2"	24"	4	NWJ	41C200-24NWJ-4	17
2"	24"	8	NWJ	41C200-24NWJ-8	17
2"	30"	4	NWJ	41C200-30NWJ-4	19
2"	30"	8	NWJ	41C200-30NWJ-8	19

* Please consult factory for special requirements.



STANDARD SAMPLERS (COMPLETE)

N&N Drilling Supply Mfr. • (800) 334-4927



Standard Sampler
Assembly



2-1/2" COMPLETE ASSEMBLY

O.D.	Length	TPI	CONN	Part#	Weight (Lb)
2-1/2"	18"	4	AW	41C212-18AW-4	20
2-1/2"	18"	8	AW	41C212-18AW-8	20
2-1/2"	24"	4	AW	41C212-24AW-4	24
2-1/2"	24"	8	AW	41C212-24AW-8	24
2-1/2"	30"	4	AW	41C212-30AW-4	27
2-1/2"	30"	8	AW	41C212-30AW-8	27
2-1/2"	18"	4	AWJ	41C212-18AWJ-4	20
2-1/2"	18"	8	AWJ	41C212-18AWJ-8	20
2-1/2"	24"	4	AWJ	41C212-24AWJ-4	24
2-1/2"	24"	8	AWJ	41C212-24AWJ-8	24
2-1/2"	30"	4	AWJ	41C212-30AWJ-4	27
2-1/2"	30"	8	AWJ	41C212-30AWJ-8	27
2-1/2"	18"	4	NW	41C212-18NW-4	21
2-1/2"	18"	8	NW	41C212-18NW-8	21
2-1/2"	24"	4	NW	41C212-24NW-4	25
2-1/2"	24"	8	NW	41C212-24NW-8	25
2-1/2"	30"	4	NW	41C212-30NW-4	28
2-1/2"	30"	8	NW	41C212-30NW-8	28
2-1/2"	18"	4	NWJ	41C212-18NWJ-4	21
2-1/2"	18"	8	NWJ	41C212-18NWJ-8	21
2-1/2"	24"	4	NWJ	41C212-24NWJ-4	25
2-1/2"	24"	8	NWJ	41C212-24NWJ-8	25
2-1/2"	30"	4	NWJ	41C212-30NWJ-4	28
2-1/2"	30"	8	NWJ	41C212-30NWJ-8	28

* Please consult factory for special requirements.



STANDARD SAMPLERS (COMPLETE)

N&N Drilling Supply Mfr. • (800) 334-4927



Standard Sampler
Assembly



3" COMPLETE ASSEMBLY

O.D.	Length	TPI	CONN	Part#	Weight (Lb)
3"	18"	4	AW	41C300-18AW-4	29
3"	18"	8	AW	41C300-18AW-8	29
3"	24"	4	AW	41C300-24AW-4	34
3"	24"	8	AW	41C300-24AW-8	34
3"	30"	4	AW	41C300-30AW-4	38
3"	30"	8	AW	41C300-30AW-8	38
3"	18"	4	AWJ	41C300-18AWJ-4	29
3"	18"	8	AWJ	41C300-18AWJ-8	29
3"	24"	4	AWJ	41C300-24AWJ-4	34
3"	24"	8	AWJ	41C300-24AWJ-8	34
3"	30"	4	AWJ	41C300-30AWJ-4	38
3"	30"	8	AWJ	41C300-30AWJ-8	38
3"	18"	4	NW	41C300-18NW-4	30
3"	18"	8	NW	41C300-18NW-8	30
3"	24"	4	NW	41C300-24NW-4	34
3"	24"	8	NW	41C300-24NW-8	34
3"	30"	4	NW	41C300-30NW-4	38
3"	30"	8	NW	41C300-30NW-8	38
3"	18"	4	NWJ	41C300-18NWJ-4	30
3"	18"	8	NWJ	41C300-18NWJ-8	30
3"	24"	4	NWJ	41C300-24NWJ-4	34
3"	24"	8	NWJ	41C300-24NWJ-8	34
3"	30"	4	NWJ	41C300-30NWJ-4	38
3"	30"	8	NWJ	41C300-30NWJ-8	38

** Please consult factory for special requirements.*



STANDARD SAMPLERS (COMPLETE)

N&N Drilling Supply Mfr. • (800) 334-4927



Standard Sampler Assembly



3-1/2" COMPLETE ASSEMBLY

O.D.	Length	TPI	CONN	Part#	Weight (Lb)
3-1/2"	18"	4	AW	41C312-18AW-4	40
3-1/2"	18"	8	AW	41C312-18AW-8	40
3-1/2"	24"	4	AW	41C312-24AW-4	45
3-1/2"	24"	8	AW	41C312-24AW-8	45
3-1/2"	30"	4	AW	41C312-30AW-4	50
3-1/2"	30"	8	AW	41C312-30AW-8	50
3-1/2"	18"	4	AWJ	41C312-18AWJ-4	40
3-1/2"	18"	8	AWJ	41C312-18AWJ-8	40
3-1/2"	24"	4	AWJ	41C312-24AWJ-4	45
3-1/2"	24"	8	AWJ	41C312-24AWJ-8	45
3-1/2"	30"	4	AWJ	41C312-30AWJ-4	50
3-1/2"	30"	8	AWJ	41C312-30AWJ-8	50
3-1/2"	18"	4	NW	41C312-18NW-4	41
3-1/2"	18"	8	NW	41C312-18NW-8	41
3-1/2"	24"	4	NW	41C312-24NW-4	46
3-1/2"	24"	8	NW	41C312-24NW-8	46
3-1/2"	30"	4	NW	41C312-30NW-4	51
3-1/2"	30"	8	NW	41C312-30NW-8	51
3-1/2"	18"	4	NWJ	41C312-18NWJ-4	41
3-1/2"	18"	8	NWJ	41C312-18NWJ-8	41
3-1/2"	24"	4	NWJ	41C312-24NWJ-4	46
3-1/2"	24"	8	NWJ	41C312-24NWJ-8	46
3-1/2"	30"	4	NWJ	41C312-30NWJ-4	51
3-1/2"	30"	8	NWJ	41C312-30NWJ-8	51

* Please consult factory for special requirements.



STANDARD SAMPLERS (COMPLETE)

N&N Drilling Supply Mfr. • (800) 334-4927



Standard Sampler Assembly



4" COMPLETE ASSEMBLY

O.D.	Length	TPI	CONN	Part#	Weight (Lb)
4"	18"	4	AW	41C400-18AW-4	47
4"	18"	8	AW	41C400-18AW-8	47
4"	24"	4	AW	41C400-24AW-4	53
4"	24"	8	AW	41C400-24AW-8	53
4"	30"	4	AW	41C400-30AW-4	59
4"	30"	8	AW	41C400-30AW-8	59
4"	18"	4	AWJ	41C400-18AWJ-4	47
4"	18"	8	AWJ	41C400-18AWJ-8	47
4"	24"	4	AWJ	41C400-24AWJ-4	53
4"	24"	8	AWJ	41C400-24AWJ-8	53
4"	30"	4	AWJ	41C400-30AWJ-4	59
4"	30"	8	AWJ	41C400-30AWJ-8	59
4"	18"	4	NW	41C400-18NW-4	47
4"	18"	8	NW	41C400-18NW-8	47
4"	24"	4	NW	41C400-24NW-4	53
4"	24"	8	NW	41C400-24NW-8	53
4"	30"	4	NW	41C400-30NW-4	59
4"	30"	8	NW	41C400-30NW-8	59
4"	18"	4	NWJ	41C400-18NWJ-4	47
4"	18"	8	NWJ	41C400-18NWJ-8	47
4"	24"	4	NWJ	41C400-24NWJ-4	53
4"	24"	8	NWJ	41C400-24NWJ-8	53
4"	30"	4	NWJ	41C400-30NWJ-4	59
4"	30"	8	NWJ	41C400-30NWJ-8	59

* Please consult factory for special requirements.



STANDARD SAMPLERS (COMPLETE)

N&N Drilling Supply Mfr. • (800) 334-4927



Standard Sampler
Assembly



4-1/2" COMPLETE ASSEMBLY

O.D.	Length	TPI	CONN	Part#	Weight (Lb)
4-1/2"	18"	4	AW	41C412-18AW-4	57
4-1/2"	18"	8	AW	41C412-18AW-8	57
4-1/2"	24"	4	AW	41C412-24AW-4	64
4-1/2"	24"	8	AW	41C412-24AW-8	64
4-1/2"	30"	4	AW	41C412-30AW-4	71
4-1/2"	30"	8	AW	41C412-30AW-8	71
4-1/2"	18"	4	AWJ	41C412-18AWJ-4	57
4-1/2"	18"	8	AWJ	41C412-18AWJ-8	57
4-1/2"	24"	4	AWJ	41C412-24AWJ-4	64
4-1/2"	24"	8	AWJ	41C412-24AWJ-8	64
4-1/2"	30"	4	AWJ	41C412-30AWJ-4	71
4-1/2"	30"	8	AWJ	41C412-30AWJ-8	71
4-1/2"	18"	4	NW	41C412-18NW-4	57
4-1/2"	18"	8	NW	41C412-18NW-8	57
4-1/2"	24"	4	NW	41C412-24NW-4	64
4-1/2"	24"	8	NW	41C412-24NW-8	64
4-1/2"	30"	4	NW	41C412-30NW-4	71
4-1/2"	30"	8	NW	41C412-30NW-8	71
4-1/2"	18"	4	NWJ	41C412-18NWJ-4	57
4-1/2"	18"	8	NWJ	41C412-18NWJ-8	57
4-1/2"	24"	4	NWJ	41C412-24NWJ-4	64
4-1/2"	24"	8	NWJ	41C412-24NWJ-8	64
4-1/2"	30"	4	NWJ	41C412-30NWJ-4	71
4-1/2"	30"	8	NWJ	41C412-30NWJ-8	71

* Please consult factory for special requirements.



N&N Drilling Supply Mfr. • (800) 334-4927

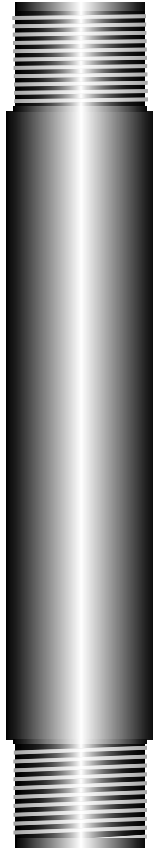

Standard Barrel

O.D.	I.D.	Length	TPI	Part#	Weight (Lb)
1-1/2"	1"	18"	8	41B112-18-8	5
1-1/2"	1"	24"	8	41B112-24-8	6
1-1/2"	1"	30"	8	41B112-30-8	8
1-3/4"	1-1/4"	18"	8	41B134-18-8	6
1-3/4"	1-1/4"	24"	8	41B134-24-8	8
1-3/4"	1-1/4"	30"	8	41B134-30-8	10
2"	1-1/2"	18"	4	41B200-18-4	7
2"	1-1/2"	18"	8	41B200-18-8	7
2"	1-1/2"	24"	4	41B200-24-4	9
2"	1-1/2"	24"	8	41B200-24-8	9
2"	1-1/2"	30"	4	41B200-30-4	11
2"	1-1/2"	30"	8	41B200-30-8	11
2-1/2"	2"	18"	4	41B212-18-4	9
2-1/2"	2"	18"	8	41B212-18-8	9
2-1/2"	2"	24"	4	41B212-24-4	12
2-1/2"	2"	24"	8	41B212-24-8	12
2-1/2"	2"	30"	4	41B212-30-4	15
2-1/2"	2"	30"	8	41B212-30-8	15
3"	2-1/2"	18"	4	41B300-18-4	10
3"	2-1/2"	18"	8	41B300-18-8	10
3"	2-1/2"	24"	4	41B300-24-4	14
3"	2-1/2"	24"	8	41B300-24-8	14
3"	2-1/2"	30"	4	41B300-30-4	17
3"	2-1/2"	30"	8	41B300-30-8	17

*** NOTE: Standard Barrel is also used with California Modified Sampler.**

*** Please consult factory for special requirements.**

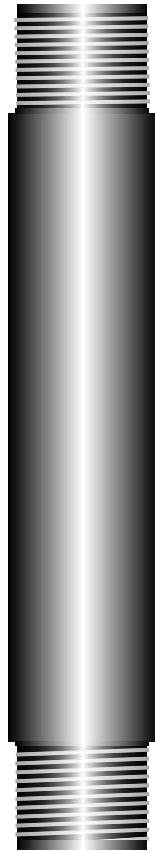

Standard Barrel

O.D.	I.D.	Length	TPI	Part#	Weight (Lb)
3-1/2"	3"	18"	4	41B312-18-4	12
3-1/2"	3"	18"	8	41B312-18-8	12
3-1/2"	3"	24"	4	41B312-24-4	16
3-1/2"	3"	24"	8	41B312-24-8	16
3-1/2"	3"	30"	4	41B312-30-4	20
3-1/2"	3"	30"	8	41B312-30-8	20
4"	3-1/2"	18"	4	41B400-18-4	14
4"	3-1/2"	18"	8	41C400-18-8	14
4"	3-1/2"	24"	4	41C400-24-4	18
4"	3-1/2"	24"	8	41C400-24-8	18
4"	3-1/2"	30"	4	41C400-30-4	22
4"	3-1/2"	30"	8	41C400-30-8	22
4-1/2"	4"	18"	4	41C412-18-4	18
4-1/2"	4"	18"	8	41C412-18-8	18
4-1/2"	4"	24"	4	41C412-24-4	22
4-1/2"	4"	24"	8	41C412-24-8	22
4-1/2"	4"	30"	4	41C412-30-4	27
4-1/2"	4"	30"	8	41C412-30-8	27

*** NOTE: Standard Barrel is also used with California Modified Sampler.**

*** Please consult factory for special requirements.**



STANDARD SAMPLER HEAD ASSEMBLY

N&N Drilling Supply Mfr. • (800) 334-4927



Standard
Head Assembly

O.D.	TPI	CONN	Part#	Weight (Lb)
1-1/2"	8	AW	41H112-AW-8	2
1-1/2"	8	AWJ	41H112-AWJ-8	2
1-3/4"	8	AW	41H134-AW-8	3
1-3/4"	8	AWJ	41H134-AWJ-8	3
2"	4	AW	41H200-AW-4	4
2"	8	AW	41H200-AW-8	4
2"	4	AWJ	41H200-AWJ-4	4
2"	8	AWJ	41H200-AWJ-8	4
2"	4	NW	41H200-NW-4	6
2"	8	NW	41H200-NW-8	6
2"	4	NWJ	41H200-NWJ-4	6
2"	8	NWJ	41H200-NWJ-8	6
2-1/2"	4	AW	41H212-AW-4	7
2-1/2"	8	AW	41H212-AW-8	7
2-1/2"	4	AWJ	41H212-AWJ-4	7
2-1/2"	8	AWJ	41H212-AWJ-8	7
2-1/2"	4	NW	41H212-NW-4	7
2-1/2"	8	NW	41H212-NW-8	7
2-1/2"	4	NWJ	41H212-NWJ-4	7
2-1/2"	8	NWJ	41H212-NWJ-8	7
3"	4	AW	41H300-AW-4	9
3"	8	AW	41H300-AW-8	9
3"	4	AWJ	41H300-AWJ-4	9
3"	8	AWJ	41H300-AWJ-8	9
3"	4	NW	41H300-NW-4	9
3"	8	NW	41H300-NW-8	9
3"	4	NWJ	41H300-NWJ-4	9
3"	8	NWJ	41H300-NWJ-8	9

** Please consult factory for special requirements.*



STANDARD SAMPLER HEAD ASSEMBLY

N&N Drilling Supply Mfr. • (800) 334-4927



Standard
Head Assembly

O.D.	TPI	CONN	Part#	Weight (Lb)
3-1/2"	4	AW	41H312-AW-4	14
3-1/2"	8	AW	41H312-AW-8	14
3-1/2"	4	AWJ	41H312-AWJ-4	14
3-1/2"	8	AWJ	41H312-AWJ-8	14
3-1/2"	4	NW	41H312-NW-4	14
3-1/2"	8	NW	41H312-NW-8	14
3-1/2"	4	NWJ	41H312-NWJ-4	14
3-1/2"	8	NWJ	41H312-NWJ-8	14
4"	4	AW	41H400-AW-4	18
4"	8	AW	41H400-AW-8	18
4"	4	AWJ	41H400-AWJ-4	18
4"	8	AWJ	41H400-AWJ-8	18
4"	4	NW	41H400-NW-4	18
4"	8	NW	41H400-NW-8	18
4"	4	NWJ	41H400-NWJ-4	18
4"	8	NWJ	41H400-NWJ-8	18
4-1/2"	4	AW	41H412-AW-4	21
4-1/2"	8	AW	41H412-AW-8	21
4-1/2"	4	AWJ	41H412-AWJ-4	21
4-1/2"	8	AWJ	41H412-AWJ-8	21
4-1/2"	4	NW	41H412-NW-4	21
4-1/2"	8	NW	41H412-NW-8	21
4-1/2"	4	NWJ	41H412-NWJ-4	21
4-1/2"	8	NWJ	41H412-NWJ-8	21

** Please consult factory for special requirements.*



CALIFORNIA MODIFIED SAMPLERS (COMPLETE)

N&N Drilling Supply Mfr. • (800) 334-4927

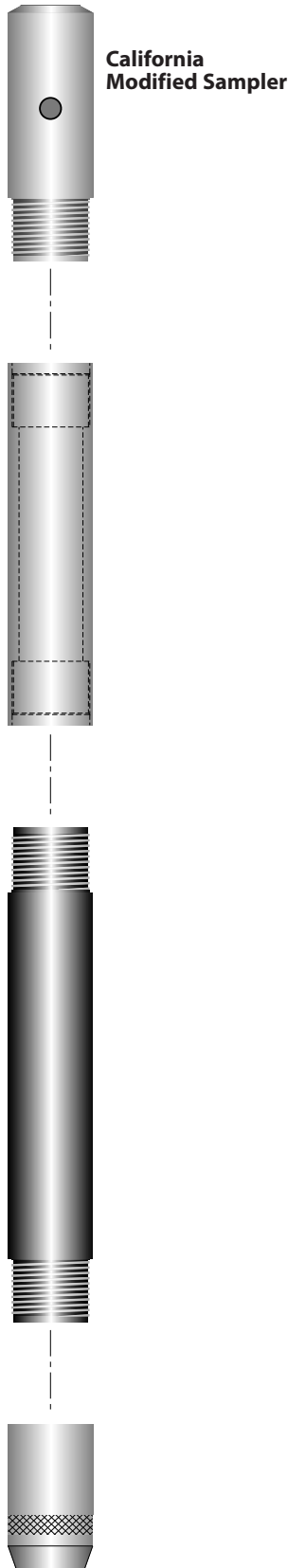

2" COMPLETE ASSEMBLY

O.D.	Length	TPI	CONN	Part#	Weight (Lb)
2"	18"	4	AW	44C200-18AW-4	13
2"	18"	8	AW	44C200-18AW-8	13
2"	24"	4	AW	44C200-24AW-4	15
2"	24"	8	AW	44C200-24AW-8	15
2"	30"	4	AW	44C200-30AW-4	17
2"	30"	8	AW	44C200-30AW-8	17
2"	18"	4	AWJ	44C200-18AWJ-4	13
2"	18"	8	AWJ	44C200-18AWJ-8	13
2"	24"	4	AWJ	44C200-24AWJ-4	15
2"	24"	8	AWJ	44C200-24AWJ-8	15
2"	30"	4	AWJ	44C200-30AWJ-4	17
2"	30"	8	AWJ	44C200-30AWJ-8	17
2"	18"	4	NW	44C200-18NW-4	15
2"	18"	8	NW	44C200-18NW-8	15
2"	24"	4	NW	44C200-24NW-4	17
2"	24"	8	NW	44C200-24NW-8	17
2"	30"	4	NW	44C200-30NW-4	19
2"	30"	8	NW	44C200-30NW-8	19
2"	18"	4	NWJ	44C200-18NWJ-4	15
2"	18"	8	NWJ	44C200-18NWJ-8	15
2"	24"	4	NWJ	44C200-24NWJ-4	17
2"	24"	8	NWJ	44C200-24NWJ-8	17
2"	30"	4	NWJ	44C200-30NWJ-4	19
2"	30"	8	NWJ	44C200-30NWJ-8	19

* Please consult factory for special requirements.



CALIFORNIA MODIFIED SAMPLERS (COMPLETE)

N&N Drilling Supply Mfr. • (800) 334-4927

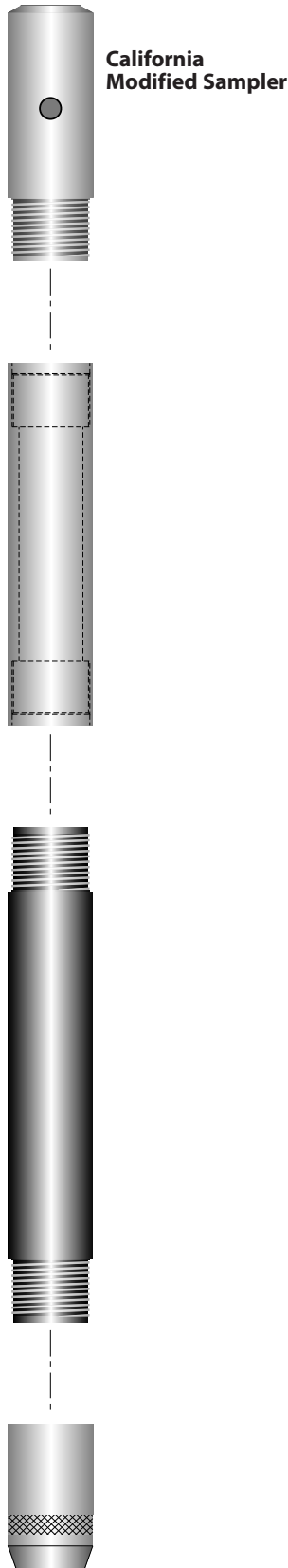

2-1/2" COMPLETE ASSEMBLY

O.D.	Length	TPI	CONN	Part#	Weight (Lb)
2-1/2"	18"	4	AW	44C212-18AW-4	20
2-1/2"	18"	8	AW	44C212-18AW-8	20
2-1/2"	24"	4	AW	44C212-24AW-4	23
2-1/2"	24"	8	AW	44C212-24AW-8	23
2-1/2"	30"	4	AW	44C212-30AW-4	26
2-1/2"	30"	8	AW	44C212-30AW-8	26
2-1/2"	18"	4	AWJ	44C212-18AWJ-4	20
2-1/2"	18"	8	AWJ	44C212-18AWJ-8	20
2-1/2"	24"	4	AWJ	44C212-24AWJ-4	23
2-1/2"	24"	8	AWJ	44C212-24AWJ-8	23
2-1/2"	30"	4	AWJ	44C212-30AWJ-4	26
2-1/2"	30"	8	AWJ	44C212-30AWJ-8	26
2-1/2"	18"	4	NW	44C212-18NW-4	20
2-1/2"	18"	8	NW	44C212-18NW-8	20
2-1/2"	24"	4	NW	44C212-24NW-4	23
2-1/2"	24"	8	NW	44C212-24NW-8	23
2-1/2"	30"	4	NW	44C212-30NW-4	26
2-1/2"	30"	8	NW	44C212-30NW-8	26
2-1/2"	18"	4	NWJ	44C212-18NWJ-4	20
2-1/2"	18"	8	NWJ	44C212-18NWJ-8	20
2-1/2"	24"	4	NWJ	44C212-24NWJ-4	23
2-1/2"	24"	8	NWJ	44C212-24NWJ-8	23
2-1/2"	30"	4	NWJ	44C212-30NWJ-4	26
2-1/2"	30"	8	NWJ	44C212-30NWJ-8	26

** Please consult factory for special requirements.*



CALIFORNIA MODIFIED SAMPLERS (COMPLETE)

N&N Drilling Supply Mfr. • (800) 334-4927

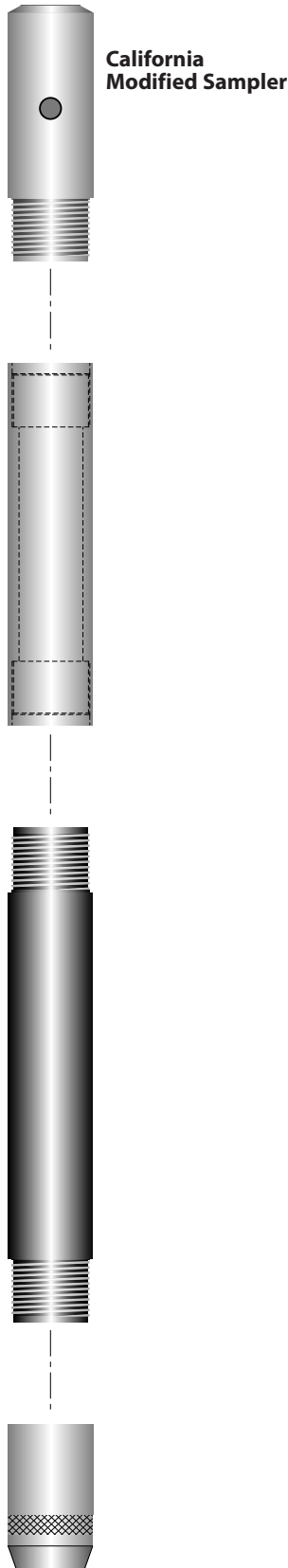

3" COMPLETE ASSEMBLY

O.D.	Length	TPI	CONN	Part#	Weight (Lb)
3"	18"	4	AW	44C300-18AW-4	25
3"	18"	8	AW	44C300-18AW-8	25
3"	24"	4	AW	44C300-24AW-4	28
3"	24"	8	AW	44C300-24AW-8	28
3"	30"	4	AW	44C300-30AW-4	31
3"	30"	8	AW	44C300-30AW-8	31
3"	18"	4	AWJ	44C300-18AWJ-4	25
3"	18"	8	AWJ	44C300-18AWJ-8	25
3"	24"	4	AWJ	44C300-24AWJ-4	28
3"	24"	8	AWJ	44C300-24AWJ-8	28
3"	30"	4	AWJ	44C300-30AWJ-4	31
3"	30"	8	AWJ	44C300-30AWJ-8	31
3"	18"	4	NW	44C300-18NW-4	25
3"	18"	8	NW	44C300-18NW-8	25
3"	24"	4	NW	44C300-24NW-4	28
3"	24"	8	NW	44C300-24NW-8	28
3"	30"	4	NW	44C300-30NW-4	31
3"	30"	8	NW	44C300-30NW-8	31
3"	18"	4	NWJ	44C300-18NWJ-4	25
3"	18"	8	NWJ	44C300-18NWJ-8	25
3"	24"	4	NWJ	44C300-24NWJ-4	28
3"	24"	8	NWJ	44C300-24NWJ-8	28
3"	30"	4	NWJ	44C300-30NWJ-4	31
3"	30"	8	NWJ	44C300-30NWJ-8	31

** Please consult factory for special requirements.*



CALIFORNIA MODIFIED SAMPLERS (COMPLETE)

N&N Drilling Supply Mfr. • (800) 334-4927

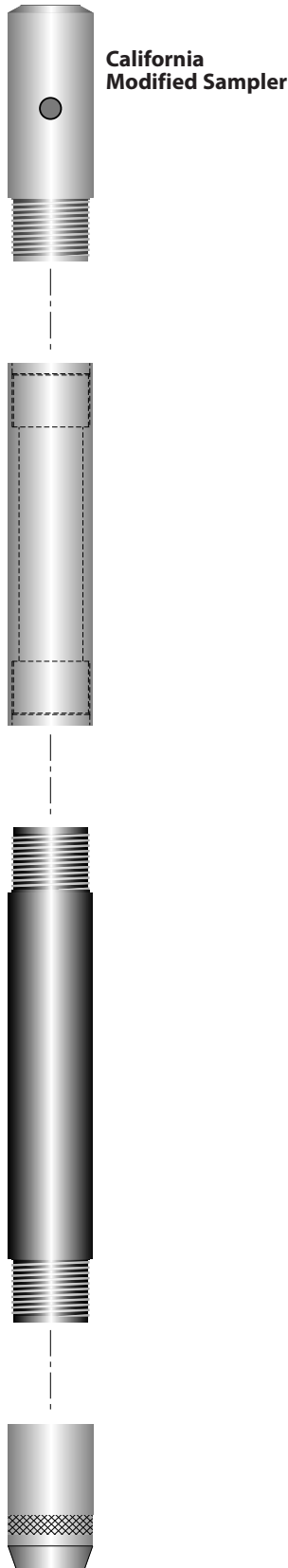

California Modified Sampler

3-1/2" COMPLETE ASSEMBLY

O.D.	Length	TPI	CONN	Part#	Weight (Lb)
3-1/2"	18"	4	AW	44C312-18AW-4	31
3-1/2"	18"	8	AW	44C312-18AW-8	31
3-1/2"	24"	4	AW	44C312-24AW-4	35
3-1/2"	24"	8	AW	44C312-24AW-8	35
3-1/2"	30"	4	AW	44C312-30AW-4	39
3-1/2"	30"	8	AW	44C312-30AW-8	39
3-1/2"	18"	4	AWJ	44C312-18AWJ-4	31
3-1/2"	18"	8	AWJ	44C312-18AWJ-8	31
3-1/2"	24"	4	AWJ	44C312-24AWJ-4	35
3-1/2"	24"	8	AWJ	44C312-24AWJ-8	35
3-1/2"	30"	4	AWJ	44C312-30AWJ-4	39
3-1/2"	30"	8	AWJ	44C312-30AWJ-8	39
3-1/2"	18"	4	NW	44C312-18NW-4	31
3-1/2"	18"	8	NW	44C312-18NW-8	31
3-1/2"	24"	4	NW	44C312-24NW-4	35
3-1/2"	24"	8	NW	44C312-24NW-8	35
3-1/2"	30"	4	NW	44C312-30NW-4	39
3-1/2"	30"	8	NW	44C312-30NW-8	39
3-1/2"	18"	4	NWJ	44C312-18NWJ-4	31
3-1/2"	18"	8	NWJ	44C312-18NWJ-8	31
3-1/2"	24"	4	NWJ	44C312-24NWJ-4	35
3-1/2"	24"	8	NWJ	44C312-24NWJ-8	35
3-1/2"	30"	4	NWJ	44C312-30NWJ-4	39
3-1/2"	30"	8	NWJ	44C312-30NWJ-8	39

* Please consult factory for special requirements.



CALIFORNIA MODIFIED SAMPLERS (COMPLETE)

N&N Drilling Supply Mfr. • (800) 334-4927

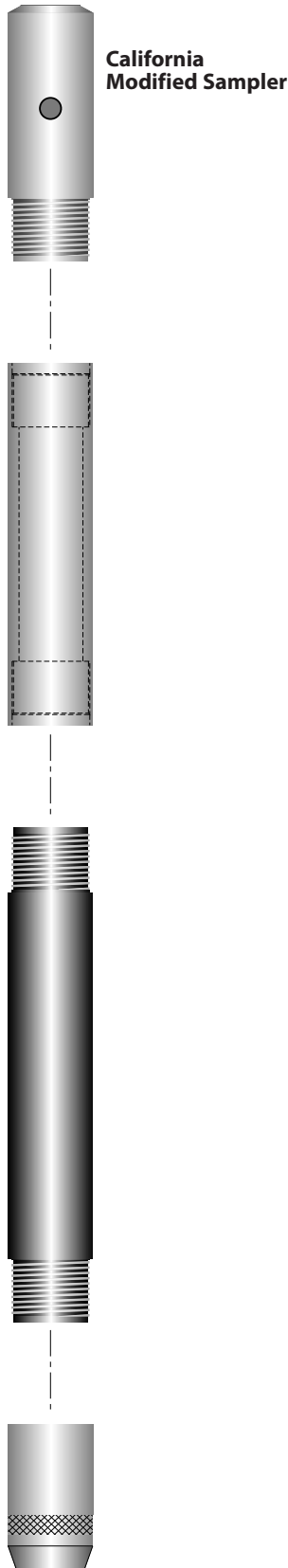

4" COMPLETE ASSEMBLY

O.D.	Length	TPI	CONN	Part#	Weight (Lb)
4"	18"	4	AW	44C400-18AW-4	40
4"	18"	8	AW	44C400-18AW-8	40
4"	24"	4	AW	44C400-24AW-4	44
4"	24"	8	AW	44C400-24AW-8	44
4"	30"	4	AW	44C400-30AW-4	48
4"	30"	8	AW	44C400-30AW-8	48
4"	18"	4	AWJ	44C400-18AWJ-4	40
4"	18"	8	AWJ	44C400-18AWJ-8	40
4"	24"	4	AWJ	44C400-24AWJ-4	44
4"	24"	8	AWJ	44C400-24AWJ-8	44
4"	30"	4	AWJ	44C400-30AWJ-4	48
4"	30"	8	AWJ	44C400-30AWJ-8	48
4"	18"	4	NW	44C400-18NW-4	40
4"	18"	8	NW	44C400-18NW-8	40
4"	24"	4	NW	44C400-24NW-4	44
4"	24"	8	NW	44C400-24NW-8	44
4"	30"	4	NW	44C400-30NW-4	48
4"	30"	8	NW	44C400-30NW-8	48
4"	18"	4	NWJ	44C400-18NWJ-4	40
4"	18"	8	NWJ	44C400-18NWJ-8	40
4"	24"	4	NWJ	44C400-24NWJ-4	44
4"	24"	8	NWJ	44C400-24NWJ-8	44
4"	30"	4	NWJ	44C400-30NWJ-4	48
4"	30"	8	NWJ	44C400-30NWJ-8	48

* Please consult factory for special requirements.



CALIFORNIA MODIFIED SAMPLERS (COMPLETE)

N&N Drilling Supply Mfr. • (800) 334-4927

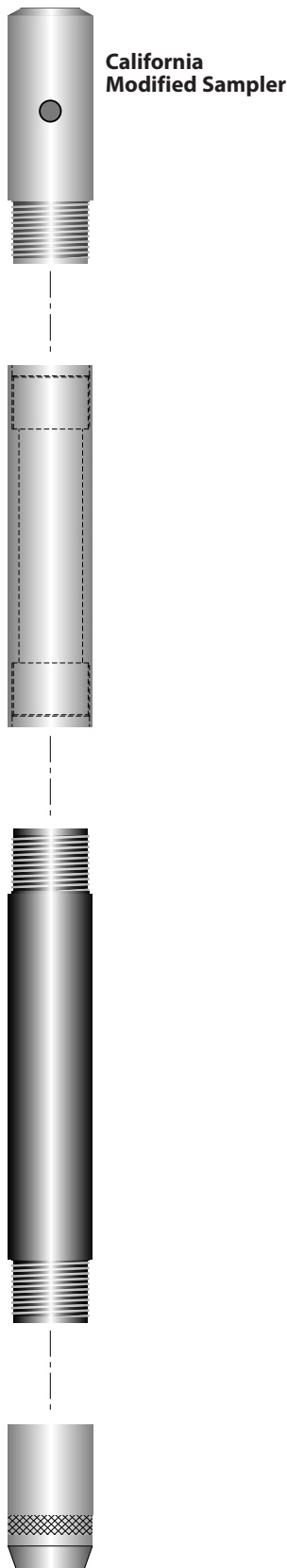

4-1/2" COMPLETE ASSEMBLY

O.D.	Length	TPI	CONN	Part#	Weight (Lb)
4-1/2"	18"	4	AW	44C412-18AW-4	48
4-1/2"	18"	8	AW	44C412-18AW-8	48
4-1/2"	24"	4	AW	44C412-24AW-4	53
4-1/2"	24"	8	AW	44C412-24AW-8	53
4-1/2"	30"	4	AW	44C412-30AW-4	58
4-1/2"	30"	8	AW	44C412-30AW-8	58
4-1/2"	18"	4	AWJ	44C412-18AWJ-4	48
4-1/2"	18"	8	AWJ	44C412-18AWJ-8	48
4-1/2"	24"	4	AWJ	44C412-24AWJ-4	53
4-1/2"	24"	8	AWJ	44C412-24AWJ-8	53
4-1/2"	30"	4	AWJ	44C412-30AWJ-4	58
4-1/2"	30"	8	AWJ	44C412-30AWJ-8	58
4-1/2"	18"	4	NW	44C412-18NW-4	48
4-1/2"	18"	8	NW	44C412-18NW-8	48
4-1/2"	24"	4	NW	44C412-24NW-4	53
4-1/2"	24"	8	NW	44C412-24NW-8	53
4-1/2"	30"	4	NW	44C412-30NW-4	58
4-1/2"	30"	8	NW	44C412-30NW-8	58
4-1/2"	18"	4	NWJ	44C412-18NWJ-4	48
4-1/2"	18"	8	NWJ	44C412-18NWJ-8	48
4-1/2"	24"	4	NWJ	44C412-24NWJ-4	53
4-1/2"	24"	8	NWJ	44C412-24NWJ-8	53
4-1/2"	30"	4	NWJ	44C412-30NWJ-4	58
4-1/2"	30"	8	NWJ	44C412-30NWJ-8	58

** Please consult factory for special requirements.*



CALIFORNIA MODIFIED SAMPLER HEAD ASSEMBLY

N&N Drilling Supply Mfr. • (800) 334-4927

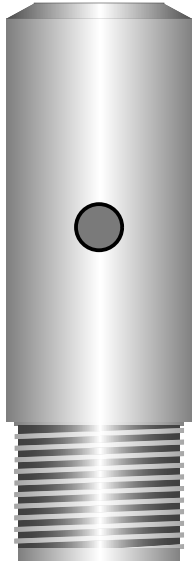

California Modified
Head Assembly

O.D.	TPI	CONN	Part#	Weight (Lb)
2"	4	AW	44H200-AW-4	3
2"	8	AW	44H200-AW-8	3
2"	4	AWJ	44H200-AWJ-4	3
2"	8	AWJ	44H200-AWJ-8	3
2"	4	NW	44H200-NW-4	5
2"	8	NW	44H200-NW-8	5
2"	4	NWJ	44H200-NWJ-4	5
2"	8	NWJ	44H200-NWJ-8	5
2-1/2"	4	AW	44H212-AW-4	6
2-1/2"	8	AW	44H212-AW-8	6
2-1/2"	4	AWJ	44H212-AWJ-4	6
2-1/2"	8	AWJ	44H212-AWJ-8	6
2-1/2"	4	NW	44H212-NW-4	6
2-1/2"	8	NW	44H212-NW-8	6
2-1/2"	4	NWJ	44H212-NWJ-4	6
2-1/2"	8	NWJ	44H212-NWJ-8	6
3"	4	AW	44H300-AW-4	8
3"	8	AW	44H300-AW-8	8
3"	4	AWJ	44H300-AWJ-4	8
3"	8	AWJ	44H300-AWJ-8	8
3"	4	NW	44H300-NW-4	8
3"	8	NW	44H300-NW-8	8
3"	4	NWJ	44H300-NWJ-4	8
3"	8	NWJ	44H300-NWJ-8	8

** Please consult factory for special requirements.*



CALIFORNIA MODIFIED SAMPLER HEAD ASSEMBLY

N&N Drilling Supply Mfr. • (800) 334-4927

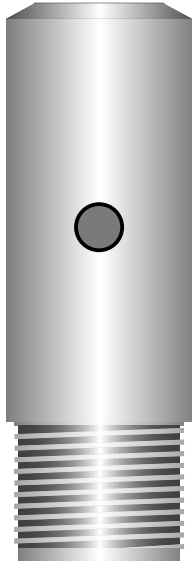

California Modified
Head Assembly

O.D.	TPI	CONN	Part#	Weight (Lb)
3-1/2"	4	AW	44H312-AW-4	13
3-1/2"	8	AW	44H312-AW-8	13
3-1/2"	4	AWJ	44H312-AWJ-4	13
3-1/2"	8	AWJ	44H312-AWJ-8	13
3-1/2"	4	NW	44H312-NW-4	13
3-1/2"	8	NW	44H312-NW-8	13
3-1/2"	4	NWJ	44H312-NWJ-4	13
3-1/2"	8	NWJ	44H312-NWJ-8	13
4"	4	AW	44H400-AW-4	17
4"	8	AW	44H400-AW-8	17
4"	4	AWJ	44H400-AWJ-4	17
4"	8	AWJ	44H400-AWJ-8	17
4"	4	NW	44H400-NW-4	17
4"	8	NW	44H400-NW-8	17
4"	4	NWJ	44H400-NWJ-4	17
4"	8	NWJ	44H400-NWJ-8	17
4-1/2"	4	AW	44H412-AW-4	20
4-1/2"	8	AW	44H412-AW-8	20
4-1/2"	4	AWJ	44H412-AWJ-4	20
4-1/2"	8	AWJ	44H412-AWJ-8	20
4-1/2"	4	NW	44H412-NW-4	20
4-1/2"	8	NW	44H412-NW-8	20
4-1/2"	4	NWJ	44H412-NWJ-4	20
4-1/2"	8	NWJ	44H412-NWJ-8	20

** Please consult factory for special requirements.*



CALIFORNIA MODIFIED SAMPLER WASTE BARREL

N&N Drilling Supply Mfr. • (800) 334-4927

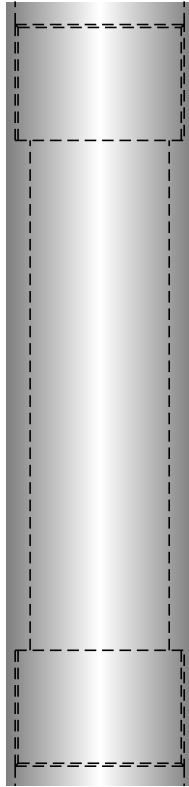

California Modified
Waste Barrel

O.D.	TPI	Part#	Weight (Lb)
2"	4	44WB200-4	3
2"	8	44WB200-8	3
2-1/2"	4	44WB212-4	4
2-1/2"	8	44WB212-8	4
3"	4	44WB300-4	5
3"	8	44WB300-8	5
3-1/2"	4	44WB312-4	6
3-1/2"	8	44WB312-8	6
4"	4	44WB400-4	7
4"	8	44WB400-8	7
4-1/2"	4	44WB412-4	8
4-1/2"	8	44WB412-8	8

** Please consult factory for special requirements.*



STAINLESS STEEL SAMPLERS (COMPLETE)

N&N Drilling Supply Mfr. • (800) 334-4927

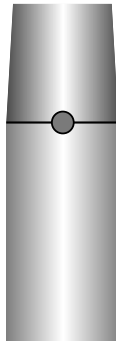

Stainless Steel
Sampler

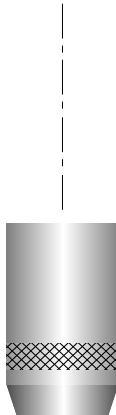

2" COMPLETE ASSEMBLY

O.D.	Length	TPI	CONN	Part#	Weight (Lb)
2"	18"	4	AW	45C200-18AW-4	13
2"	18"	8	AW	45C200-18AW-8	13
2"	24"	4	AW	45C200-24AW-4	13
2"	24"	8	AW	45C200-24AW-8	13
2"	18"	4	AWJ	45C200-18AWJ-4	13
2"	18"	8	AWJ	45C200-18AWJ-8	13
2"	24"	4	AWJ	45C200-24AWJ-4	13
2"	24"	8	AWJ	45C200-24AWJ-8	13
2"	18"	4	NW	45C200-18NW-4	15
2"	18"	8	NW	45C200-18NW-8	15
2"	24"	4	NW	45C200-24NW-4	15
2"	24"	8	NW	45C200-24NW-8	15
2"	18"	4	NWJ	45C200-18NWJ-4	15
2"	18"	8	NWJ	45C200-18NWJ-8	15
2"	24"	4	NWJ	45C200-24NWJ-4	15
2"	24"	8	NWJ	45C200-24NWJ-8	15

** Please consult factory for special requirements.*



STAINLESS STEEL SAMPLERS (COMPLETE)

N&N Drilling Supply Mfr. • (800) 334-4927

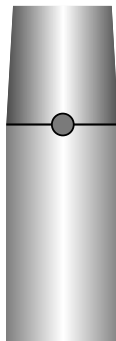

Stainless Steel
Sampler

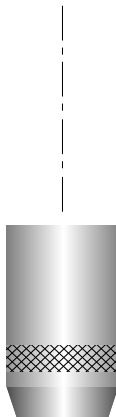

3" COMPLETE ASSEMBLY

O.D.	Length	TPI	CONN	Part#	Weight (Lb)
3"	18"	4	AW	45C300-18AW-4	25
3"	18"	8	AW	45C300-18AW-8	25
3"	24"	4	AW	45C300-24AW-4	25
3"	24"	8	AW	45C300-24AW-8	25
3"	18"	4	AWJ	45C300-18AWJ-4	25
3"	18"	8	AWJ	45C300-18AWJ-8	25
3"	24"	4	AWJ	45C300-24AWJ-4	25
3"	24"	8	AWJ	45C300-24AWJ-8	25
3"	18"	4	NW	45C300-18NW-4	28
3"	18"	8	NW	45C300-18NW-8	28
3"	24"	4	NW	45C300-24NW-4	28
3"	24"	8	NW	45C300-24NW-8	28
3"	18"	4	NWJ	45C300-18NWJ-4	28
3"	18"	8	NWJ	45C300-18NWJ-8	28
3"	24"	4	NWJ	45C300-24NWJ-4	28
3"	24"	8	NWJ	45C300-24NWJ-8	28

** Please consult factory for special requirements.*



STAINLESS STEEL SAMPLER COMPONENTS

N&N Drilling Supply Mfr. • (800) 334-4927



Stainless Steel Barrel

STAINLESS STEEL BARREL

O.D.	I.D.	Length	TPI	Part#	Weight (Lb)
2"	1-1/2"	18"	4	45B200-18-4	8
2"	1-1/2"	18"	8	45B200-18-8	8
2"	1-1/2"	24"	4	45B200-24-4	10
2"	1-1/2"	24"	8	45B200-24-8	10
3"	2-1/2"	18"	4	45B300-18-4	11
3"	2-1/2"	18"	8	45B300-18-8	11
3"	2-1/2"	24"	4	45B300-24-4	15
3"	2-1/2"	24"	8	45B300-24-8	15

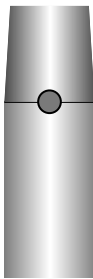

Stainless Steel Head Assembly

STAINLESS STEEL HEAD ASSEMBLY

O.D.	TPI	Connection	Part#	Weight (Lb)
2"	4	AW	45H200-AW-4	4
2"	8	AW	45H200-AW-8	4
2"	4	AWJ	45H200-AWJ-4	4
2"	8	AWJ	45H200-AWJ-8	4
2"	4	NW	45H200-NW-4	6
2"	8	NW	45H200-NW-8	6
2"	4	NWJ	45H200-NWJ-4	6
2"	8	NWJ	45H200-NWJ-8	6
3"	4	AW	45H300-AW-4	10
3"	8	AW	45H300-AW-8	10
3"	4	AWJ	45H300-AWJ-4	10
3"	8	AWJ	45H300-AWJ-8	10
3"	4	NW	45H300-NW-4	14
3"	8	NW	45H300-NW-8	14
3"	4	NWJ	45H300-NWJ-4	14
3"	8	NWJ	45H300-NWJ-8	14



Stainless Steel Shoe

STAINLESS STEEL SHOE

O.D.	TPI	Part#	Weight (Lb)
2"	4	45S200-B-4	1.0
2"	8	45S200-B-8	1.0
3"	4	45S300-B-4	1.5
4"	8	45S400-B-8	1.5

* Please consult factory for special requirements.



N&N Drilling Supply Mfr. • (800) 334-4927

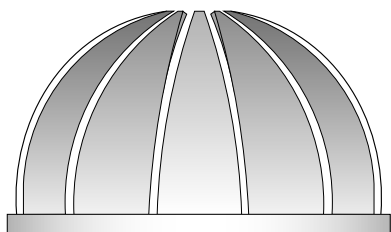

Plastic Basket Retainer - Standard

PLASTIC BASKET RETAINER - STANDARD

Sampler O.D.	Part#	Weight (Oz)
2"	40PR200	0.2
2-1/2"	40PR212	0.4
3"	40PR300	0.6
3-1/2"	40PR312	0.8
4"	40PR400	1.3
4-1/2"	40PR412	1.8

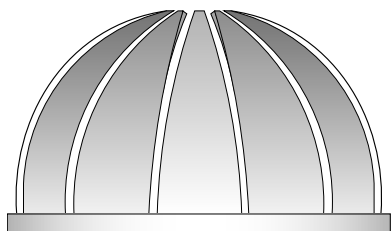

Plastic Basket Retainer - Soft

PLASTIC BASKET RETAINER - SOFT

Sampler O.D.	Part#	Weight (Oz)
2"	40PRS200	0.2
2-1/2"	40PRS212	0.3
3"	40PRS300	0.5
3-1/2"	40PRS312	0.7
4"	40PRS400	1.2
4-1/2"	40PRS412	1.7

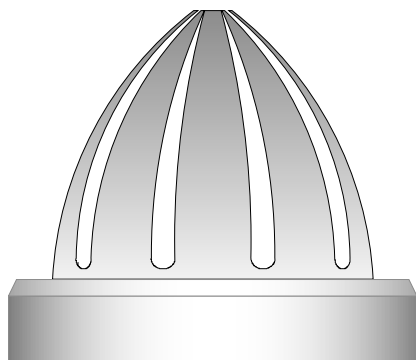

Steel Basket Retainer - Complete

STEEL BASKET RETAINER - COMPLETE

Sampler O.D.	Part#	Weight (Oz)
2"	40SR200	1.50
2-1/2"	40SR212	1.70
3"	40SR300	2.70
3-1/2"	40SR312	2.90
4"	40SR400	3.90
4-1/2"	40SR412	3.11

** Please consult factory for special requirements.*



N&N Drilling Supply Mfr. • (800) 334-4927

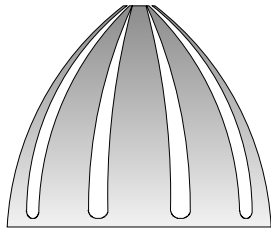

Steel Retainer Spring

STEEL RETAINER SPRINGS		
Sampler O.D.	Part#	Weight (Oz)
2"	40SB200	0.3
3"	40SB300	0.9

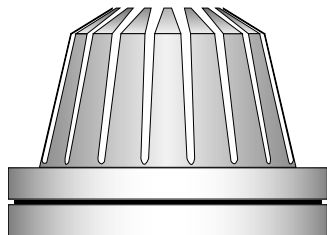

Steel Retainer Double Ring

STEEL RETAINER DOUBLE RING		
Sampler O.D.	Part#	Weight (Oz)
2"	40DRR200	1.2
3"	40DRR300	1.8

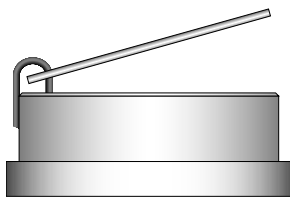

Trap Valve

TRAP VALVE		
Sampler O.D.	Part#	Weight (Oz)
2"	40TV200	2.5
2-1/2"	40TV212	5.1
3"	40TV300	7.9
3-1/2"	40TV312	10.3
4"	40TV400	13.6
4-1/2"	40TV412	16.3

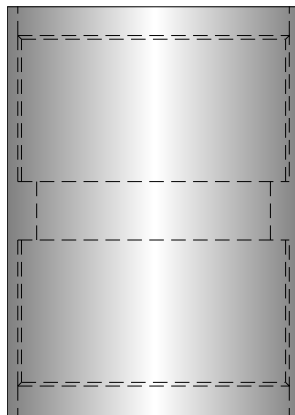

Couplings

COUPLINGS			
Sampler O.D.	TPI	Part#	Weight (Oz)
1-1/2"	8	40CP112-8	8.3
1-3/4"	8	40CP134-8	8.7
2"	4	40CP200-4	11.1
2"	8	40CP200-8	11.1
2-1/2"	4	40CP212-4	12.6
2-1/2"	8	40CP212-8	12.6
3"	4	40CP300-4	14.2
3"	8	40CP300-8	14.2
3-1/2"	4	40CP312-4	15.9
3-1/2"	8	40CP312-8	15.9
4"	4	40CP400-4	18.3
4"	8	40CP400-8	18.3
4-1/2"	4	40CP412-4	20.9
4-1/2"	8	40CP412-8	20.9

** Please consult factory for special requirements.*



N&N Drilling Supply Mfr. • (800) 334-4927

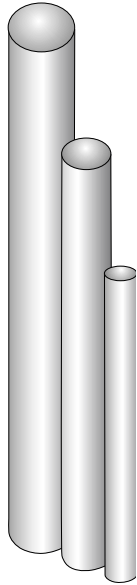

Plastic Liners

PLASTIC LINERS

Sampler O.D.	Length	Part#	Weight (Oz)
2"	18"	40PL2180	0.30
2"	24"	40PL2240	0.40
2"	30"	40PL2300	0.50
2-1/2"	18"	40PL21218	0.50
2-1/2"	24"	40PL21224	0.60
2-1/2"	30"	40PL21230	0.70
3"	18"	40PL3180	0.70
3"	24"	40PL3240	0.80
3"	30"	40PL3300	0.90
3-1/2"	18"	40PL31218	0.90
3-1/2"	24"	40PL31224	0.10
3-1/2"	30"	40PL31230	0.11
4"	18"	40PL4180	0.11
4"	24"	40PL4240	0.12
4"	30"	40PL4300	0.13
4-1/2"	18"	40PL41218	0.13
4-1/2"	24"	40PL41224	0.14
4-1/2"	30"	40PL41230	0.16

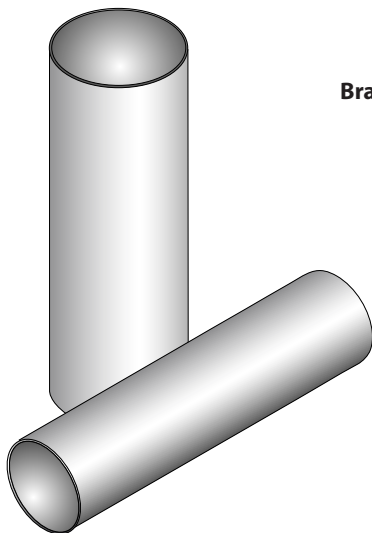

Brass Liners

BRASS LINERS

Sampler O.D.	Length	Part#	Weight (Lb)
2"	18"	40BL2180	1.5
2"	24"	40BL2240	2.0
2"	30"	40BL2300	2.5
2-1/2"	18"	40BL21218	3.0
2-1/2"	24"	40BL21224	3.5
2-1/2"	30"	40BL21230	4.0
3"	18"	40BL3180	3.5
3"	24"	40BL3240	4.0
3"	30"	40BL3300	4.5
3-1/2"	18"	40BL31218	3.8
3-1/2"	24"	40BL31224	4.3
3-1/2"	30"	40BL31230	4.8
4"	18"	40BL4180	4.1
4"	24"	40BL4240	4.9
4"	30"	40BL4300	5.7
4-1/2"	18"	40BL41218	4.6
4-1/2"	24"	40BL41224	5.5
4-1/2"	30"	40BL41230	6.4

** Please consult factory for special requirements.*



N&N Drilling Supply Mfr. • (800) 334-4927

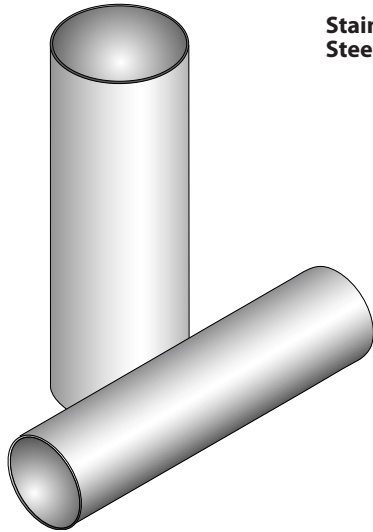

Stainless Steel Liners

STAINLESS STEEL LINERS

Sampler O.D.	Length	Part#	Weight (Lb)
2"	18"	40SL2180	1.5
2"	24"	40SL2240	2.0
2"	30"	40SL2300	2.5
2-1/2"	18"	40SL21218	3.0
2-1/2"	24"	40SL21224	3.5
2-1/2"	30"	40SL21230	4.0
3"	18"	40SL3180	3.5
3"	24"	40SL3240	4.0
3"	30"	40SL3300	4.5
3-1/2"	18"	40SL31218	3.8
3-1/2"	24"	40SL31224	4.3
3-1/2"	30"	40SL31230	4.8
4"	18"	40SL4180	4.1
4"	24"	40SL4240	4.9
4"	30"	40SL4300	5.7
4-1/2"	18"	40SL41218	4.6
4-1/2"	24"	40SL41224	5.5
4-1/2"	30"	40SL41230	6.4

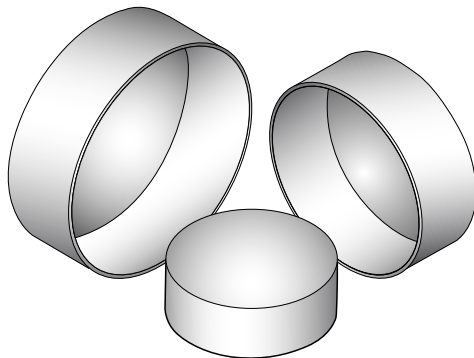

Plastic Caps

PLASTIC CAPS

Sampler O.D.	Part#	Weight (Oz)
2"	40PC200	2.0
2-1/2"	40PC212	2.2
3"	40PC300	2.4
3-1/2"	40PC312	2.8
4"	40PC400	3.0
4-1/2"	40PC412	3.2

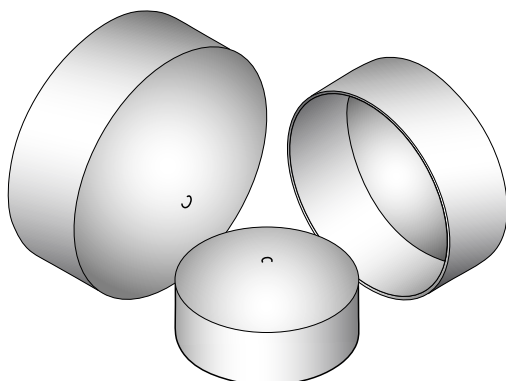

Vinyl Caps

VINYL CAPS

Sampler O.D.	Part#	Weight (Oz)
2"	40VC200	2.2
2-1/2"	40VC212	2.4
3"	40VC300	2.6
3-1/2"	40VC312	2.8
4"	40VC400	3.0
4-1/2"	40VC412	3.2

*** Please consult factory for special requirements.**